

# Assembly Instruction Sheet #IS-8318W12C-1 (Clear) For Style 8318W12C-1 (Clear)







**Tools Required:** Flathead screwdriver, Phillips screwdriver, pliers, wire cutters, wire strippers, electrical tape, safety glasses.

**Light Source:** (3) E12 Base Bulb 60W Maximum (Not Include).  
**Preparation:** Identify and inspect all parts before beginning installation. Check package content list and diagrams below to be sure all parts are present. If any parts are missing or damaged, do not attempt to assemble, install, or operate the fixture. Contact customer service for replacement parts.

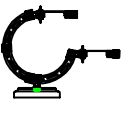
## Warnings and Cautions

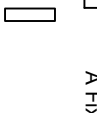
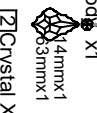
Turn off electricity at circuit breaker or main fuse box before installation. Consult a licensed electrician if in doubt. These instructions are provided for your safety. It is very important you read them completely before installing the fixture. We strongly recommend that a licensed, professional electrician perform the installation. Disconnect fixture from power source before replacing bulbs. Make sure bulbs are given sufficient time to cool before removal.

## Package Contents

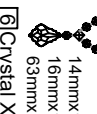
-  A Fixture Body X1
-  1 Crystal X1 2
-  4 Crystal X2
-  3 Candle Cover X3
-  2 Crystal X1
-  5 Crystal X1
-  3 Bobèche X3
-  3 Crystal X2
-  6 Crystal X1

PART	DESCRIPTION	QUANTITY
BB	Wire nut	2pcs
CC	Screw	2pcs

## Hardware Contents



## STEP 1 - Release Mounting bracket from Ceiling Canopy.

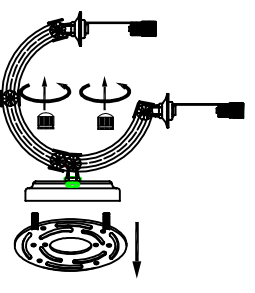

Figure 1

**STEP 2 - Attach Mounting bracket to Outlet Box**  
A. Pass the supply wires through the Mounting bracket (EE). Attach the Mounting bracket (EE) to the Outlet Box with the head of the Green Ground Screw facing you. Secure it with Outlet Box Screws. Tighten until snug.

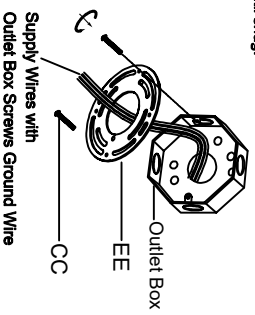

Figure 2

## STEP 3 - Wire Connections

A. Use standard wire connectors to make all wire connections. Twist connectors until wires are tightly joined together. Wrap each connection with approved electrical tape and carefully stuff all the connected wires into the Outlet Box.

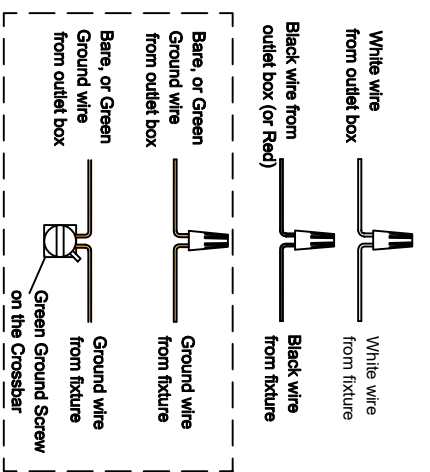

Figure 3

## STEP 4 - Install Backplate to Ceiling

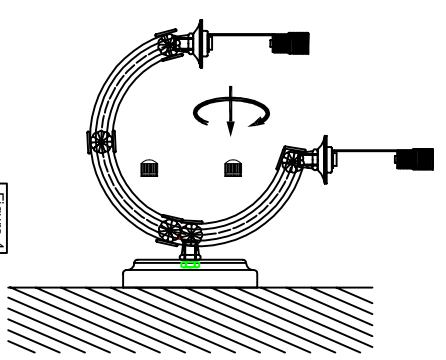

Figure 4

## STEP 5 - Install bulb, Socket sleeve, Bobèche

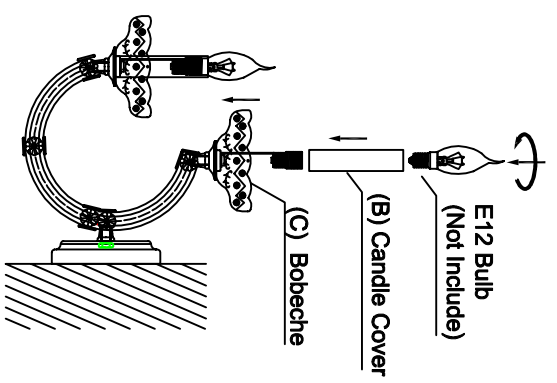

Figure 5

## STEP 6 - Install Crystal.

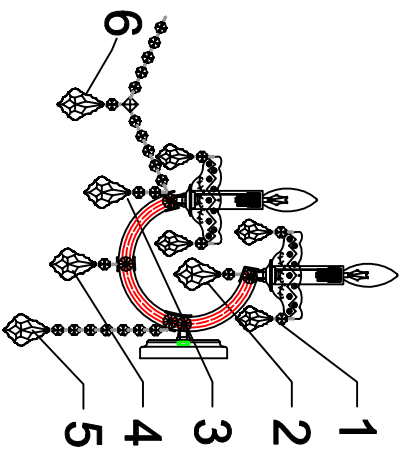

Figure 6