

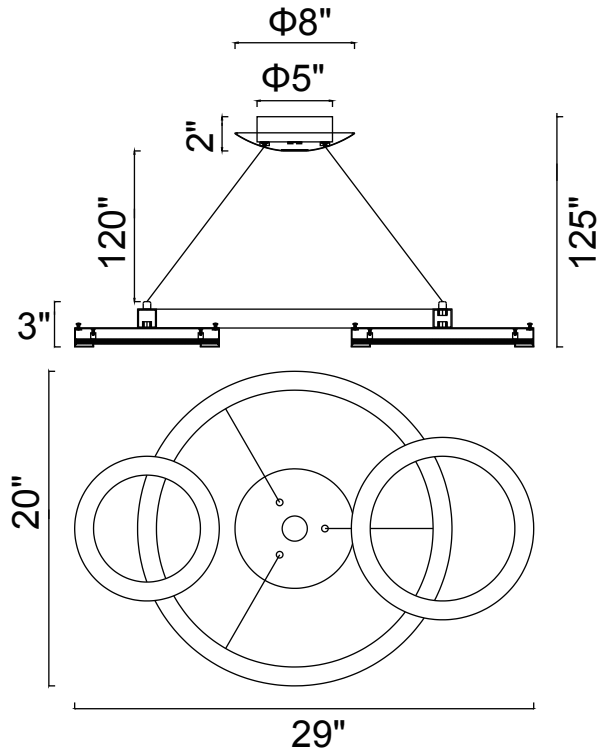

PROJECT: _____
 FIXTURE TYPE: _____
 LOCATION: _____
 CONTACT/PHONE: _____



Item	1215P29-2-625
Collection	Deux Lunes
Category	Chandelier
Finish	Sun Gold & Black
Glass	-----
Crystal	-----
Acrylic	Frosted

Shade Color	-----
Min Assembled Height	17"
Max Assembled Height	125"
Width	29"
Length	20"
Extension Wall Mounts	-----
Input	120V AC,60HZ,AC

Lumens	832
Light Source	Integrated LED
Bulb Info.	16W
Included	Yes
Dimmable	Yes
Colour Temp	3000K
Weight	11.0 Lbs

CWI Lighting
 140 Steelcase Rd W
 Markham, ON L3R 3J9
 Canada

CWI Lighting
 295 Fire Tower Dr
 Tonawanda, NY 14150
 USA

Dallas Showroom: #4707
 2100 N Stemmons Fwy
 Dallas, TX 75207
 USA

High Point Showroom: #IH108
 210 E Commerce Ave
 High Point, NC 27260
 USA

