

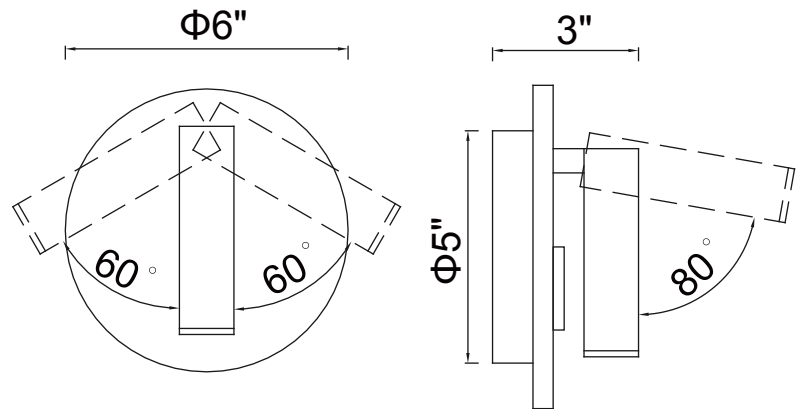

PROJECT: _____
 FIXTURE TYPE: _____
 LOCATION: _____
 CONTACT/PHONE: _____



Item	1241W6-101
Collection	Private I
Category	Wall Light
Finish	Matte Black
Glass	-----
Crystal	-----
Acrylic	Frosted

Shade Color	-----
Min Assembled Height	5"
Max Assembled Height	-----
Width	6"
Length	-----
Extension Wall Mounts	3"
Input	120V AC,60HZ,AC

Lumens	260
Light Source	Integrated LED
Bulb Info.	5W
Included	Yes
Dimmable	Yes
Colour Temp	3000
Weight	0.66 Lbs

CWI Lighting
 140 Steelcase Rd W
 Markham, ON L3R 3J9
 Canada

CWI Lighting
 295 Fire Tower Dr
 Tonawanda, NY 14150
 USA

Dallas Showroom: #4707
 2100 N Stemmons Fwy
 Dallas, TX 75207
 USA

High Point Showroom: #IH108
 210 E Commerce Ave
 High Point, NC 27260
 USA

