

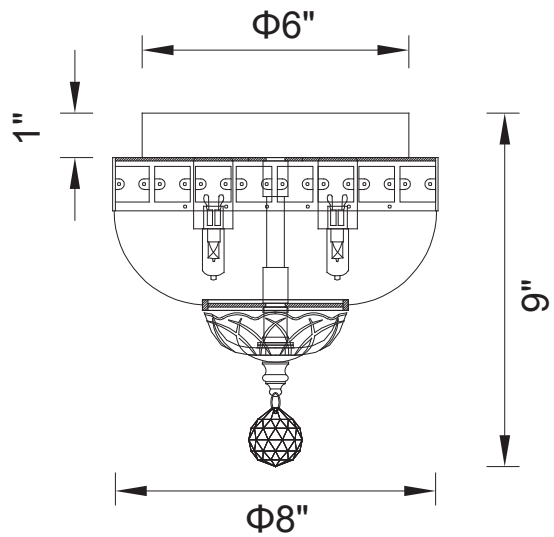

PROJECT: _____
 FIXTURE TYPE: _____
 LOCATION: _____
 CONTACT/PHONE: _____



Item	8003C8C
Collection	STEFANIA
Category	Flush Mount
Finish	Chrome
Glass	-----
Crystal	Clear
Acrylic	-----

Shade Color	-----
Min Assembled Height	9"
Max Assembled Height	-----
Width	8"
Length	-----
Extension Wall Mounts	-----
Input	120V AC,60HZ,AC

Lumens	-----
Light Source	E12
Bulb Info.	2x60W
Included	-----
Dimmable	Yes
Colour Temp	-----
Weight	1.10 Lbs

CWI Lighting
 140 Steelcase Rd W
 Markham, ON L3R 3J9
 Canada

CWI Lighting
 295 Fire Tower Dr
 Tonawanda, NY 14150
 USA

Dallas Showroom: #4707
 2100 N Stemmons Fwy
 Dallas, TX 75207
 USA

High Point Showroom: #IH108
 210 E Commerce Ave
 High Point, NC 27260
 USA

