

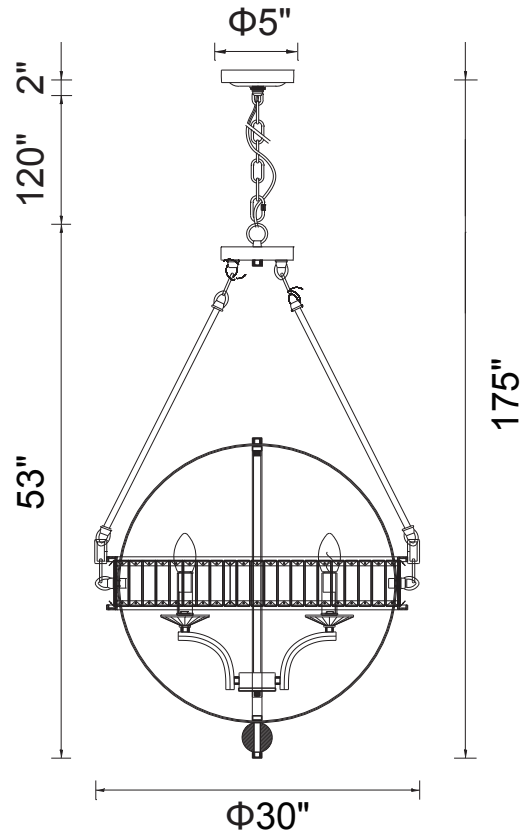

PROJECT: \_\_\_\_\_  
 FIXTURE TYPE: \_\_\_\_\_  
 LOCATION: \_\_\_\_\_  
 CONTACT/PHONE: \_\_\_\_\_



Item	9957P30-6-101
Collection	ARKANSAS
Category	Chandelier
Finish	Black
Glass	-----
Crystal	Clear
Acrylic	-----

Shade Color	-----
Min Assembled Height	55"
Max Assembled Height	175"
Width	30"
Length	-----
Extension Wall Mounts	-----
Input	120V AC,60HZ,AC

Lumens	-----
Light Source	E12
Bulb Info.	6x60W
Included	-----
Dimmable	Yes
Colour Temp	-----
Weight	37.84 Lbs

**CWI Lighting**  
 140 Steelcase Rd W  
 Markham, ON L3R 3J9  
 Canada

**CWI Lighting**  
 295 Fire Tower Dr  
 Tonawanda, NY 14150  
 USA

**Dallas Showroom: #4707**  
 2100 N Stemmons Fwy  
 Dallas, TX 75207  
 USA

**High Point Showroom: #IH108**  
 210 E Commerce Ave  
 High Point, NC 27260  
 USA

